

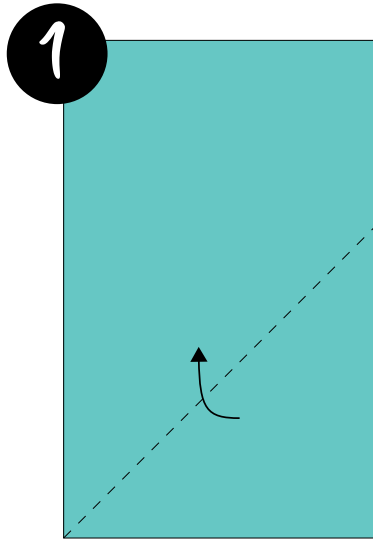

# Bias Tape

## Cutting Bias Tape Strips

This technique can be used to cut any size piece of fabric into bias strips! It is much more manageable if it is less than a yard. Square up the fabric first.



Open fabric up so that it is one layer. Fold diagonally lining up the crosswise grain on the end with the selvage.

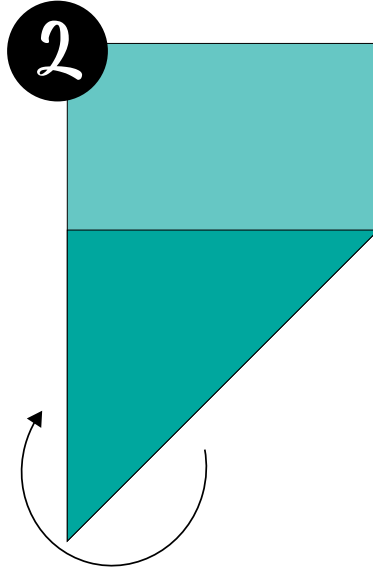

This will create a diagonal 45° fold on the bias. Rotate whole piece so that the fold is parallel to your body.

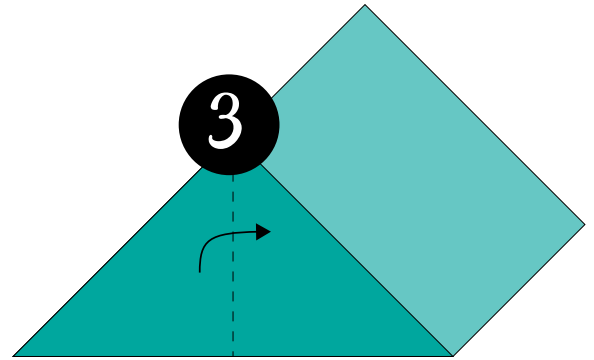

Now you will start to fold a square/rectangle based on that initial fold. First fold to create a vertical line at a 90° angle to the first fold.

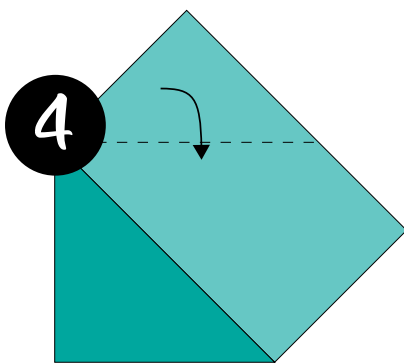

Next make a fold parallel to the first fold and 90° from the vertical fold.

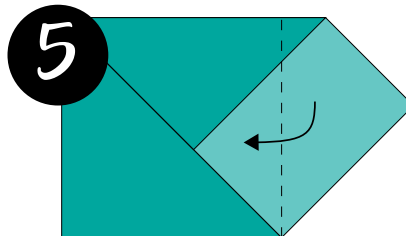

Lastly, make another vertical fold at a 90° angle to the first fold.

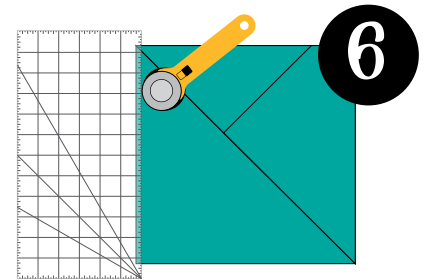

Using a rotary cutter and ruler trim off the fold to create a clean straight edge on one side of the rectangle.

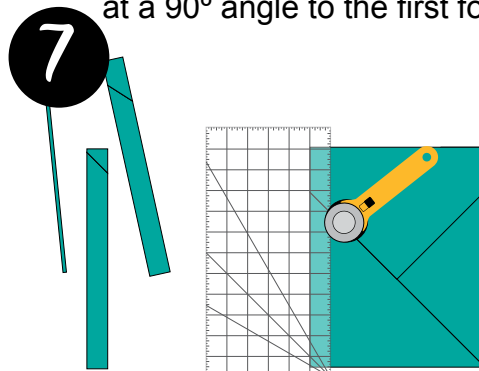

Slide ruler over and cut remaining fabric into bias strips of the desired width.



# Making Bias Tape

## Sew Bias Tape Strips Together

Place strips right sides together at a 90° angle overlapping the ends as shown below. Pin.

Note: It doesn't matter if the ends of the strip are cut straight - just overlap them so that you can see the full width of each strip beyond the edge of the other strip.

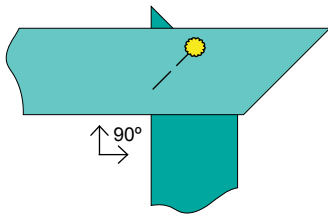

Rotate and sew a straight line from the top point where the strips cross to the bottom point where they cross.

If you're having trouble sewing the line straight, draw the line first using an erasable fabric marker.

Note: You'll know the strips are oriented properly at your machine if the length of the both strips is to the left of the needle and just the ends are to the right.

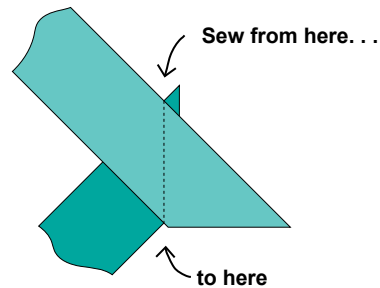

## Trim Bias Tape

Using a small pair of fabric scissors, trim using these three steps.

1

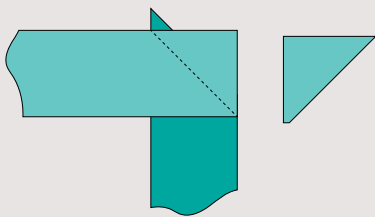

Using the outside edge of one bias strip as a guide trim the overlap flush to that side.

2

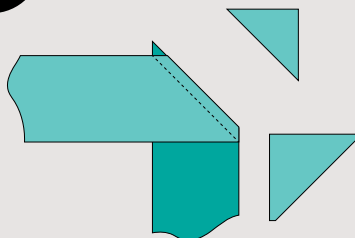

Cut diagonally 1/4" from seam line.

3

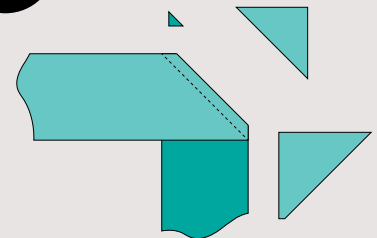

Lastly, trim overlap at top flush with the outside edge of second strip.

## Press Bias Tape

Using a Bias Tape Maker by Dritz or Clover, follow the directions in the package to press your bias strips into bias tape.